

Absaugarme & Zubehör

Absaugarm Ø200mm, Länge=2m

Serienmäßig mit eingebauter Drosselklappe, Gelenke außen und somit glatte Rohre von innen, Aluminium Absaughaube Ø350mm, einsetzbar bis 80°C – erforderlicher Volumenstrom: 1400 - 2500m³/h

 WELAFIX

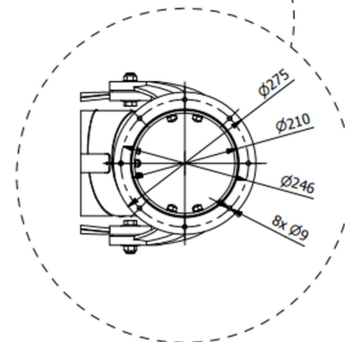
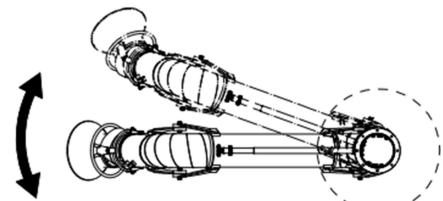
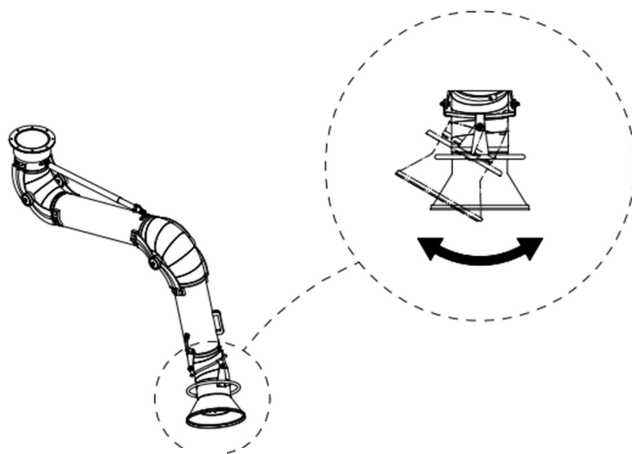
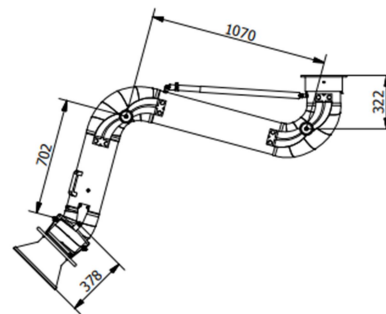
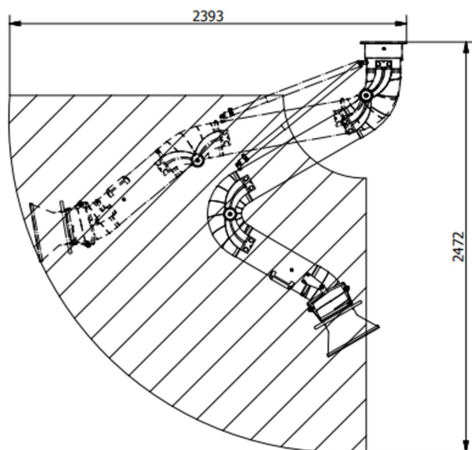

WELAFIX Industrietechnik GmbH
Von Nagel Straße 26a · 59302
Oelde Tel.: 0 2522 8300-52 · info@welifix.de