

# WELAfix

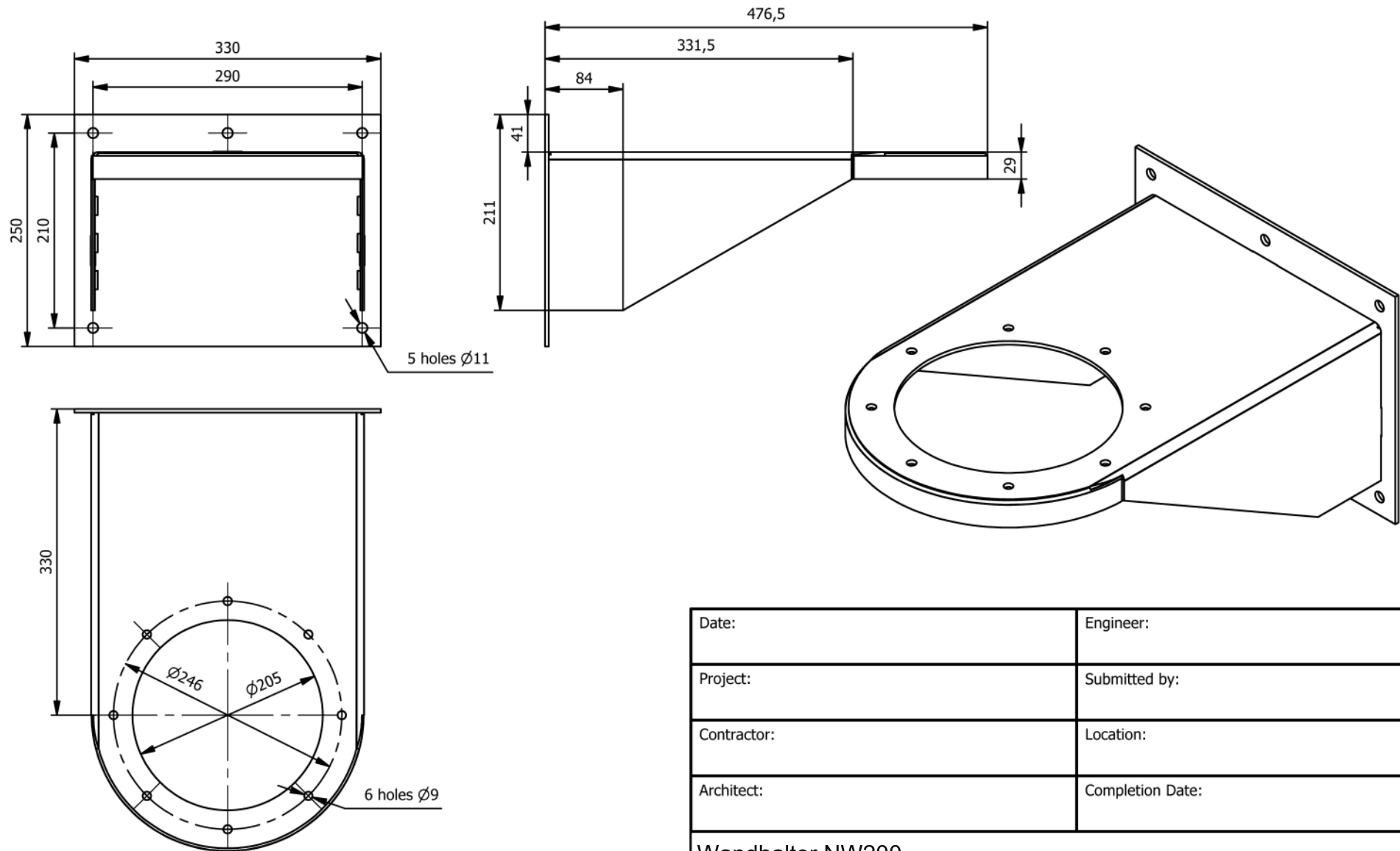

Date:	Engineer:
Project:	Submitted by:
Contractor:	Location:
Architect:	Completion Date:

Wandhalter NW200